



сайт: www.ziptrading.org почта: sales@ziptrading.org тел.: +7 (495) 36-36-697

ШКИВЫ ДЛЯ КЛИНОВЫХ РЕМНЕЙ SPB

Belt-pulley





Taper Bore V-pulleys

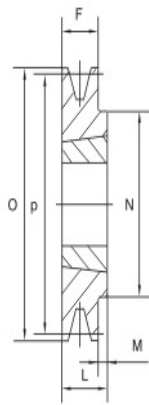

TYPE1

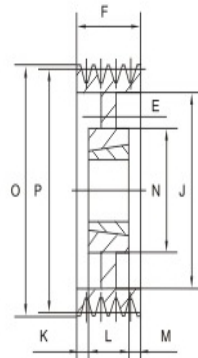

TYPE6

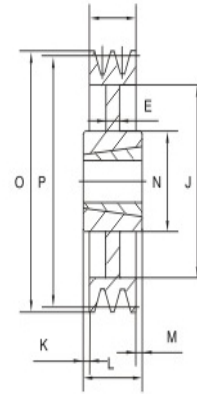

TYPE7

SPB-1

ITEM NO.	NO.OF GROOVES	PD	O.D	TYPE	BUSH NO.	MAX BORE	E	F	J	K	L	M	N
SPB100-01	1	100.0	107.0	1	1610	42	—	25	—	—	25	—	—
SPB112-01	1	112.0	119.0	1	1610	42	—	25	—	—	25	—	—
SPB118-01	1	118.0	125.0	1	1610	42	—	25	—	—	25	—	—
SPB125-01	1	125.0	132.0	1	1610	42	—	25	—	—	25	—	—
SPB132-01	1	132.0	139.0	1	1610	42	—	25	—	—	25	—	—
SPB140-01	1	140.0	147.0	1	1610	42	—	25	—	—	25	—	—
SPB150-01	1	150.0	157.0	1	1610	42	—	25	—	—	25	—	—
SPB160-01	1	160.0	167.0	1	1610	42	—	25	—	—	25	—	—
SPB170-01	1	170.0	177.0	1	1610	42	—	25	—	—	25	—	—
SPB180-01	1	180.0	187.0	6	1610	42	10	25	137	—	25	—	80
SPB190-01	1	190.0	197.0	7	2012	50	10	25	147	3.5	32	3.5	100
SPB200-01	1	200.0	207.0	7	2012	50	10	25	157	3.5	32	3.5	100
SPB212-01	1	212.0	219.0	7	2012	50	10	25	169	3.5	32	3.5	100
SPB224-01	1	224.0	231.0	7	2012	50	10	25	181	3.5	32	3.5	100
SPB236-01	1	236.0	243.0	7	2012	50	10	25	193	3.5	32	3.5	100
SPB250-01	1	250.0	257.0	7	2012	50	10	25	207	3.5	32	3.5	100
SPB280-01	1	280.0	287.0	7	2012	50	10	25	237	3.5	32	3.5	100
SPB315-01	1	315.0	322.0	7	2012	50	10	25	272	3.5	32	3.5	100

Taper Bore V-pulleys

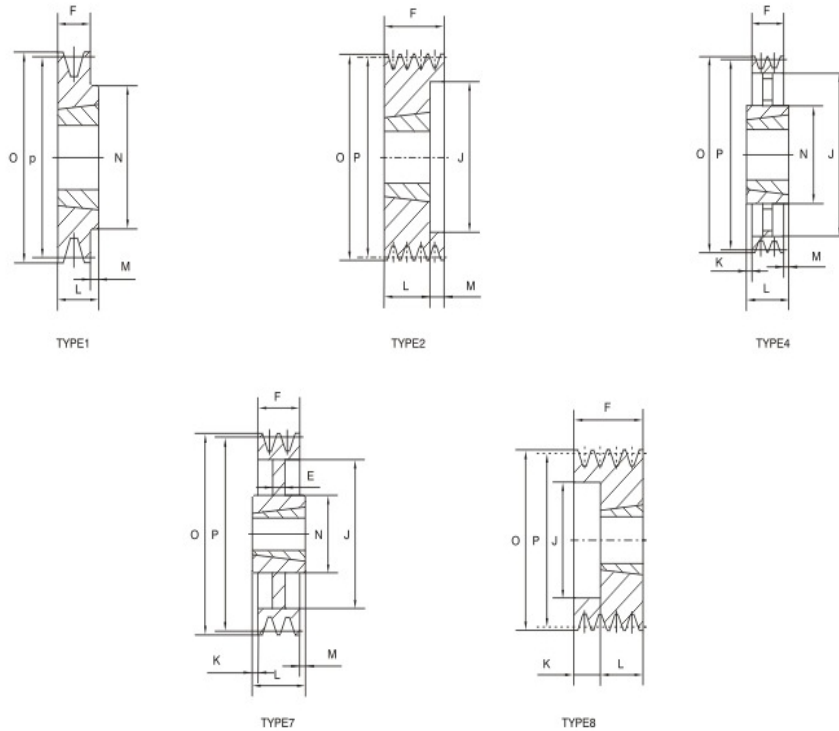

SPB-2

ITEM NO.	NO.OF GROOVES	PD	O.D	TYPE	BUSH NO.	MAX BORE	E	F	J	K	L	M	N
SPB100-02	2	100.0	107.0	8	1610	42	—	44	62	—	25	19	—
SPB112-02	2	112.0	119.0	2	1610	42	—	44	72	—	25	19	—
SPB118-02	2	118.0	127.0	2	1610	42	—	44	78	—	25	19	—
SPB125-02	2	125.0	132.0	2	2012	50	—	44	82	—	32	12	—
SPB132-02	2	132.0	139.0	2	2012	50	—	44	89	—	32	12	—
SPB140-02	2	140.0	147.0	2	2012	50	—	44	97	—	32	12	—
SPB150-02	2	150.0	157.0	2	2012	50	—	44	107	—	32	12	—
SPB160-02	2	160.0	167.0	2	2012	50	—	44	117	—	32	12	—
SPB170-02	2	170.0	177.0	2	2012	50	—	44	127	—	32	12	—
SPB180-02	2	180.0	187.0	1	2517	60	—	44	—	—	45	1	120
SPB190-02	2	190.0	197.0	1	2517	60	—	44	—	—	45	1	120
SPB200-02	2	200.0	207.0	1	2517	60	—	44	—	—	45	1	120
SPB212-02	2	212.0	219.0	7	2517	60	10	44	169	—	45	1	120
SPB224-02	2	224.0	231.0	7	2517	60	10	44	181	1	45	—	120
SPB236-02	2	236.0	243.0	7	2517	60	10	44	193	1	45	—	120
SPB250-02	2	250.0	257.0	7	2517	60	10	44	207	1	45	—	120
SPB280-02	2	280.0	287.0	7	2517	60	12	44	237	1	45	—	120
SPB300-02	2	300.0	307.0	7	2517	60	12	44	257	1	45	—	120
SPB315-02	2	315.0	322.0	7	2517	60	12	44	272	1	45	—	120
SPB335-02	2	335.0	342	7	2517	60	12	44	292	1	45	—	120
SPB355-02	2	355.0	362.0	4	3020	75		44	312	3.5	51	3.5	150
SPB400-02	2	400.0	407.0	4	3020	75		44	357	3.5	51	3.5	150
SPB450-02	2	450.0	457.0	4	3020	75		44	407	3.5	51	3.5	150
SPB500-02	2	500.0	507.0	4	3020	75		44	457	3.5	51	3.5	150
SPB560-02	2	560.0	567.0	4	3030	75		44	517	4	76	28	150
SPB630-02	2	630.0	637.0	4	3030	75		44	587	4	76	28	150



Taper Bore V-pulleys

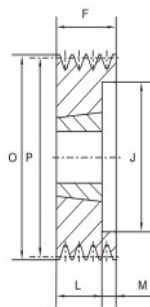

TYPE2

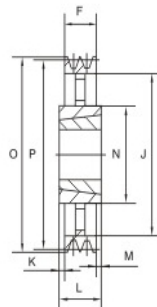

TYPE4

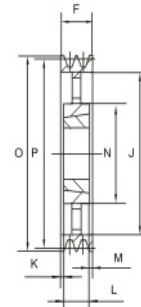

TYPE5

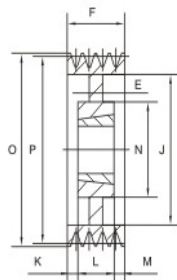

TYPE6

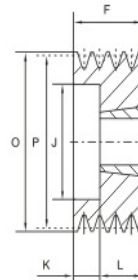

TYPE8

SPB-3

ITEM NO.	NO.OF GROOVES	PD	O.D	TYPE	BUSH NO.	MAX BORE	E	F	J	K	L	M	N
SPB100-03	3	100.0	107.0	8	1610	42	—	63	57	—	25	38	—
SPB112-03	3	112.0	119.0	2	1610	42	—	63	72	—	25	38	—
SPB118-03	3	118.0	125.0	2	1610	42	—	63	78	—	25	38	—
SPB125-03	3	125.0	132.0	2	2012	50	—	63	82	—	32	31	—
SPB132-03	3	132.0	139.0	2	2012	50	—	63	89	—	32	31	—
SPB140-03	3	140.0	147.0	2	2012	50	—	63	97	—	32	31	—
SPB150-03	3	150.0	157.0	2	2517	60	—	63	107	—	45	18	—
SPB160-03	3	160.0	167.0	2	2517	60	—	63	117	—	45	18	—
SPB170-03	3	170.0	177.0	2	2517	60	—	63	127	—	45	18	—
SPB180-03	3	180.0	187.0	2	2517	60	—	63	137	—	45	18	—
SPB190-03	3	190.0	197.0	2	2517	60	—	63	147	—	45	18	—
SPB200-03	3	200.0	207.0	2	2517	60	—	63	157	—	45	18	—
SPB212-03	3	212.0	219.0	6	2517	60	12	63	169	—	45	18	120
SPB224-03	3	224.0	231.0	6	2517	60	12	63	181	—	45	18	120
SPB236-03	3	236.0	243.0	6	2517	60	10	63	193	—	45	18	120
SPB250-03	3	250.0	257.0	6	3020	75	12	63	207	—	51	12	150
SPB280-03	3	280.0	287.0	6	3020	75	13	63	237	6	51	6	150
SPB300-03	3	300.0	307.0	6	3020	75	13	63	257	6	51	6	150
SPB315-03	3	315.0	322.0	6	3020	75	13	63	272	6	51	6	150
SPB335-03	3	335.0	342.0	6	3020	75	13	63	292	6	51	6	150
SPB355-03	3	355.0	362.0	5	3020	75	—	63	312	6	51	6	150
SPB400-03	3	400.0	407.0	4	3535	90	—	63	357	13	89	13	170
SPB450-03	3	450.0	457.0	4	3535	90	—	63	407	—	89	26	170
SPB500-03	3	500.0	507.0	4	3535	90	—	63	457	—	89	26	170
SPB560-03	3	560.0	567.0	4	3535	90	—	63	517	—	89	26	170
SPB630-03	3	630.0	637.0	4	3535	90	—	63	587	—	89	26	170
SPB710-03	3	710.0	717.0	4	3535	90	—	63	664	4	89	22	170
SPB800-03	3	800.0	807.0	4	3535	90	—	63	754	4	89	22	170
SPB900-03	3	900.0	907.0	4	3535	90	—	63	854	4	89	22	170
SPB1000-03	3	1000.0	1007.0	4	4040	100	—	63	954	6	102	33	200
SPB1250-03	3	1250.0	1257.0	4	4040	100	—	63	1204	6	102	33	200

Taper Bore V-pulleys

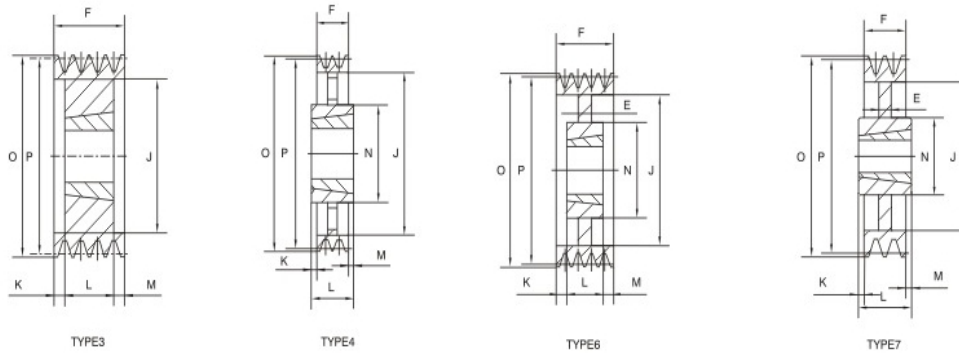

SPB-4

ITEM NO.	NO.OF GROOVES	PD	O.D	TYPE	BUSH NO.	MAX BORE	E	F	J	K	L	M	N
SPB125-04	4	125.0	132.0	3	2012	50	—	82	82	25	32	25	—
SPB132-04	4	132.0	139.0	3	2012	50	—	82	89	25	32	25	—
SPB140-04	4	140.0	147.0	3	2517	60	—	82	97	18.5	45	18.5	—
SPB150-04	4	150.0	157.0	3	2517	60	—	82	107	18.5	45	18.5	—
SPB160-04	4	160.0	167.0	3	2517	60	—	82	117	18.5	45	18.5	—
SPB170-04	4	170.0	177.0	3	2517	60	—	82	127	18.5	45	18.5	—
SPB180-04	4	180.0	187.0	3	2517	60	—	82	137	18.5	45	18.5	—
SPB190-04	4	190.0	197.0	3	2517	60	—	82	147	18.5	45	18.5	—
SPB200-04	4	200.0	207.0	3	3020	75	—	82	157	15.5	51	15.5	—
SPB212-04	4	212.0	219.0	3	3020	75	—	82	169	15.5	51	15.5	—
SPB224-04	4	224.0	231.0	3	3020	75	—	82	181	15.5	51	15.5	—
SPB236-04	4	236.0	243.0	3	3020	75	—	82	193	15.5	51	15.5	—
SPB250-04	4	250.0	257.0	6	3020	75	14	82	207	15.5	51	15.5	150
SPB280-04	4	280.0	287.0	6	3020	75	16	82	237	15.5	51	15.5	150
SPB300-04	4	300.0	307.0	6	3020	75	16	82	257	15.5	51	15.5	150
SPB315-04	4	315.0	322.0	7	3535	90	16	82	272	3.5	89	3.5	170
SPB335-04	4	335.0	342.0	7	3535	90	16	82	292	3.5	89	3.5	170
SPB355-04	4	355.0	362.0	7	3535	90	16	82	312	3.5	89	3.5	170
SPB400-04	4	400.0	407.0	4	3535	90	—	82	357	3.5	89	3.5	170
SPB450-04	4	450.0	457.0	4	3535	90	—	82	407	—	89	7	170
SPB500-04	4	500.0	507.0	4	3535	90	—	82	457	—	89	7	170
SPB560-04	4	560.0	567.0	4	3535	90	—	82	517	—	89	7	170
SPB630-04	4	630.0	637.0	4	3535	90	—	82	587	—	89	7	170
SPB710-04	4	710.0	717.0	4	3535	90	—	82	664	3.5	89	3.5	187
SPB800-04	4	800.0	807.0	4	4040	100	—	82	754	4	102	16	200
SPB900-04	4	900.0	907.0	4	4040	100	—	82	854	4	102	16	216
SPB1000-04	4	1000.0	1007.0	4	4040	100	—	82	954	4	102	16	216
SPB1250-04	4	1250.0	1257.0	4	4545	110	—	82	1204	6	114	26	225

Taper Bore V-pulleys

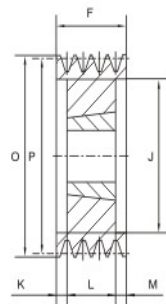

TYPE3

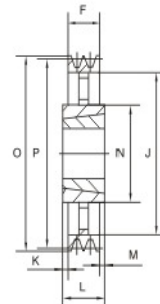

TYPE4

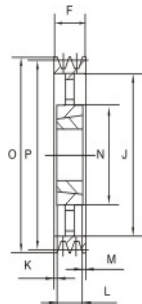

TYPE5

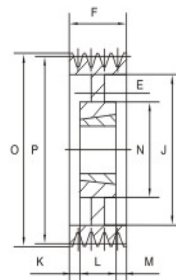

TYPE6



TYPE8

SPB-5

ITEM NO.	NO.OF GROOVES	P.D	O.D	TYPE	BUSH NO.	MAX BORE	E	F	J	K	L	M	N
SPB125-05	5	125.0	132.0	8	2012	50	—	101	82	69	32	—	—
SPB132-05	5	132.0	139.0	8	2517	60	—	101	89	56	45	—	—
SPB140-05	5	140.0	147.0	3	2517	60	—	101	97	28	45	28	—
SPB150-05	5	150.0	157.0	3	2517	60	—	101	107	28	45	28	—
SPB160-05	5	160.0	167.0	3	2517	60	—	101	117	28	45	28	—
SPB170-05	5	170.0	177.0	3	3020	75	—	101	127	25	51	25	—
SPB180-05	5	180.0	187.0	3	3020	75	—	101	137	25	51	25	—
SPB190-05	5	190.0	197.0	3	3020	75	—	101	147	25	51	25	—
SPB200-05	5	200.0	207.0	3	3020	75	—	101	157	25	51	25	—
SPB212-05	5	212.0	219.0	3	3020	75	—	101	169	25	51	25	—
SPB224-05	5	224.0	231.0	3	3020	75	—	101	181	25	51	25	—
SPB236-05	5	236.0	243.0	3	3535	90	—	101	193	6	89	6	—
SPB250-05	5	250.0	257.0	3	3535	90	—	101	207	6	89	6	—
SPB280-05	5	280.0	287.0	6	3535	90	18	101	237	6	89	6	170
SPB300-05	5	300.0	307.0	6	3535	90	18	101	257	6	89	6	170
SPB315-05	5	315.0	322.0	6	3535	90	18	101	272	6	89	6	170
SPB335-05	5	335.0	342.0	6	3535	90	16	101	292	6	89	6	170
SPB355-05	5	355.0	362.0	5	3535	90	—	101	312	6	89	6	170
SPB400-05	5	400.0	407.0	5	3535	90	—	101	357	6	89	6	170
SPB450-05	5	450.0	457.0	5	3535	90	—	101	407	—	89	12	170
SPB500-05	5	500.0	507.0	5	3535	90	—	101	457	—	89	12	170
SPB560-05	5	560.0	567.0	4	4040	100	—	101	517	—	102	1	200
SPB630-05	5	630.0	637.0	4	4040	100	—	101	587	—	102	1	200
SPB710-05	5	710.0	717.0	4	4040	100	—	101	664	0.5	102	0.5	200
SPB800-05	5	800.0	807.0	4	4040	100	—	101	754	0.5	102	0.5	200
SPB900-05	5	900.0	907.0	4	4545	110	—	101	854	6.5	114	6.5	225
SPB1000-05	5	1000.0	1007.0	4	4545	110	—	101	954	6.5	114	6.5	225
SPB1250-05	5	1250.0	1257.0	4	4545	110	—	101	1204	6.5	114	6.5	225

Taper Bore V-pulleys

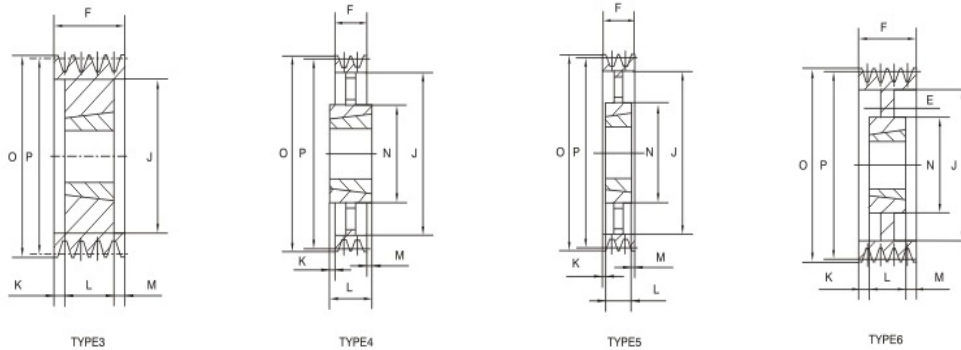

SPB-6

ITEM NO.	NO.OF GROOVES	PD	O.D	TYPE	BUSH NO.	MAX BORE	E	F	J	K	L	M	N
SPB140-06	6	140.0	147.0	3	2517	60	—	120	97	37.5	45	37.5	—
SPB150-06	6	150.0	157.0	3	2517	60	—	120	107	37.5	45	37.5	—
SPB160-06	6	160.0	167.0	3	3020	75	—	120	117	34.5	51	34.5	—
SPB170-06	6	170.0	177.0	3	3020	75	—	120	127	34.5	51	34.5	—
SPB180-06	6	180.0	187.0	3	3020	75	—	120	137	34.5	51	34.5	—
SPB190-06	6	190.0	197.0	3	3020	75	—	120	147	34.5	51	34.5	—
SPB200-06	6	200.0	207.0	3	3020	75	—	120	157	34.5	51	34.5	—
SPB212-06	6	212.0	219.0	3	3535	90	—	120	169	15.5	89	15.5	—
SPB224-06	6	224.0	231.0	3	3535	90	—	120	181	15.5	89	15.5	—
SPB236-06	6	236.0	243.0	3	3535	90	—	120	193	15.5	89	15.5	—
SPB250-06	6	250.0	257.0	3	3535	90	—	120	207	15.5	89	15.5	—
SPB280-06	6	280.0	287.0	6	3535	90	18	120	237	15.5	89	15.5	170
SPB300-06	6	300.0	307.0	6	3535	90	18	120	257	15.5	89	15.5	170
SPB315-06	6	315.0	322.0	6	3535	90	18	120	272	15.5	89	15.5	170
SPB335-06	6	335.0	342.0	6	3535	90	18	120	292	15.5	89	15.5	170
SPB355-06	6	355.0	362.0	6	3535	90	18	120	312	15.5	89	15.5	170
SPB400-06	6	400.0	407.0	5	3535	90	—	120	357	15.5	89	15.5	170
SPB450-06	6	450.0	457.0	5	4040	100	—	120	407	—	102	18	200
SPB500-06	6	500.0	507.0	5	4040	100	—	120	457	—	102	18	200
SPB560-06	6	560.0	567.0	5	4040	100	—	120	517	—	102	18	200
SPB630-06	6	630.0	637.0	5	4040	100	—	120	587	—	102	18	200
SPB710-06	6	710.0	717.0	5	4040	100	—	120	664	9	102	9	216
SPB800-06	6	800.0	807.0	5	4545	110	—	120	754	3	114	3	225
SPB900-06	6	900.0	907.0	5	4545	110	—	120	854	3	114	3	225
SPB1000-06	6	1000.0	1007.0	5	4545	110	—	120	954	3	114	3	225
SPB1250-06	6	1250.0	1257.0	4	5050	125	—	120	1204	3.5	127	3.5	245



Taper Bore V-pulleys

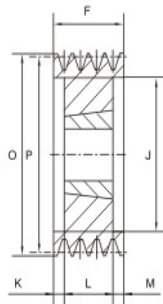

TYPE3

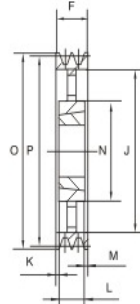

TYPE5

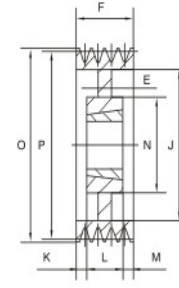

TYPE6

SPB-8

ITEM NO.	NO.OF GROOVES	PD	O.D	TYPE	BUSH NO.	MAX BORE	E	F	J	K	L	M	N
SPB160-08	8	160.0	167.0	3	3020	75	—	158	117	53.5	51	53.5	—
SPB170-08	8	170.0	177.0	3	3030	75	—	158	127	41	76	41	—
SPB180-08	8	180.0	187.0	3	3030	75	—	158	137	41	76	41	—
SPB190-08	8	190.0	197.0	3	3030	75	—	158	147	41	76	41	—
SPB200-08	8	200.0	207.0	3	3535	90	—	158	157	34.5	89	34.5	—
SPB212-08	8	212.0	219.0	3	3535	90	—	158	169	34.5	89	34.5	—
SPB224-08	8	224.0	231.0	3	3535	90	—	158	181	34.5	89	34.5	—
SPB236-08	8	236.0	243.0	3	3535	90	—	158	193	34.5	89	34.5	—
SPB250-08	8	250.0	257.0	3	3535	90	—	158	207	34.5	89	34.5	—
SPB280-08	8	280.0	287.0	3	3535	90	—	158	237	34.5	89	34.5	—
SPB300-08	8	300.0	307.0	6	3535	90	20	158	257	34.5	89	34.5	170
SPB315-08	8	315.0	322.0	6	3535	90	18	158	272	34.5	89	34.5	170
SPB335-08	8	335.0	342.0	6	3535	90	18	158	292	34.5	89	34.5	170
SPB355-08	8	355.0	362.0	6	3535	90	18	158	312	34.5	89	34.5	170
SPB400-08	8	400.0	407.0	5	4040	100	—	158	357	28	102	28	200
SPB450-08	8	450.0	457.0	5	4040	100	—	158	407	28	102	28	200
SPB500-08	8	500.0	507.0	5	4040	100	—	158	457	28	102	28	200
SPB560-08	8	560.0	567.0	5	4545	110	—	158	517	22	114	22	225
SPB630-08	8	630.0	637.0	5	4545	110	—	158	587	22	114	22	225
SPB710-08	8	710.0	717.0	5	4545	110	—	158	664	22	114	22	225
SPB800-08	8	800.0	807.0	5	4545	110	—	158	754	22	114	22	225
SPB900-08	8	900.0	907.0	5	4545	110	—	158	854	22	114	22	225
SPB1000-08	8	1000.0	1007.0	5	5050	125	—	158	954	15.5	127	15.5	245
SPB1250-08	8	1250.0	1257.0	5	5050	125	—	158	1204	15.5	127	15.5	245

Taper Bore V-pulleys

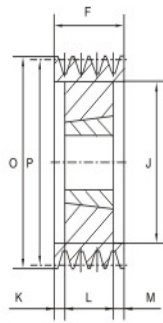

TYPE3

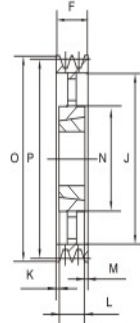

TYPE5

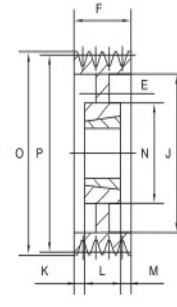

TYPE6

SPB-10

ITEM NO.	NO.OF GROOVES	P.D	O.D	TYPE	BUSH NO.	MAX BORE	E	F	J	K	L	M	N
SPB224-10	10	224.0	231.0	3	3535	90	—	196	181	53.5	89	53.5	—
SPB236-10	10	236.0	243.0	3	3535	90	—	196	193	53.5	89	53.5	—
SPB250-10	10	250.0	257.0	3	3535	90	—	196	207	53.5	89	53.5	—
SPB280-10	10	280.0	287.0	3	3535	90	—	196	237	53.5	89	53.5	—
SPB315-10	10	315.0	322.0	6	3535	90	18	196	272	53.5	89	53.5	170
SPB335-10	10	335.0	342.0	6	4040	100	20	196	292	47	102	47	200
SPB355-10	10	355.0	362.0	6	4040	100	20	196	312	47	102	47	200
SPB400-10	10	400.0	407.0	5	4040	100	—	196	357	47	102	47	200
SPB450-10	10	450.0	457.0	5	4545	110	—	196	407	41	114	41	225
SPB500-10	10	500.0	507.0	5	4545	110	—	196	457	41	114	41	225
SPB560-10	10	560.0	567.0	5	4545	110	—	196	517	41	114	41	225
SPB630-10	10	630.0	637.0	5	4545	110	—	196	587	41	114	41	225
SPB710-10	10	710.0	717.0	5	4545	110	—	196	664	41	114	41	225
SPB800-10	10	800.0	807.0	5	4545	110	—	196	754	41	114	41	225
SPB900-10	10	900.0	907.0	5	5050	125	—	196	854	34.5	127	34.5	245
SPB1000-10	10	1000.0	1007.0	5	5050	125	—	196	954	34.5	127	34.5	245